

EXPO KYLAR

Ezy Cooler OF 1300, 2st hyllor, LED, Hjul, R290a

BxDxH : 442x442x1320 mm

Ezy Cooler OF 1350, 2st hyllor, LED, Hjul, R290a

BxDxH : 442x442x1370 mm

Ezy Cooler OF 1600, 3st hyllor, LED, Hjul, R290a

BxDxH : 442x442x1630 mm

Ezy Cooler OT 40, LED, Hjul, R290a

BxDxH : 442x442x1030

EzyCooler OT 60, LED, Hjul, R290a

BxDxH : 600x442x1030

VM 90/91 E

SUBSTER® SR 150 2 hyllor ingår

Open Front Cooler

SUBSTER® SR 100

Open Front Cooler

Pos Nr.	Beskrivning	Antal	St Pris
	Ezy Cooler OF 1300, 2st hyllor, LED, Hjul, R290a BxDxH : 442x442x1320 mm		
	Ezy Cooler OF 1350, 2st hyllor, LED, Hjul, R290a BxDxH : 442x442x1370 mm		
	Ezy Cooler OF 1600, 3st hyllor, LED, Hjul, R290a BxDxH : 442x442x1630 mm		
	Ezy Cooler OT 40, LED, Hjul, R290a BxDxH : 442x442x1030		
	EzyCooler OT 60, LED, Hjul, R290a BxDxH : 600x442x1030		
6	VM 90/91 E		
7-11	SUBSTER® SR 150 2 hyllor ingår Open Front Cooler		
12-15	SUBSTER® SR 100 Open Front Cooler		
	PROFILERING ingår i priser		
	Summa totalt		

Ezy Cooler OF 1300/1350



Ezy Cooler OF 1600



EzyCooler OT 60



Ezy Cooler OT 40.





OPEN TOP PLEXI 80
 W: 440 D: 440 H: 1320 mm**
 - 330 ml cans: 100 pcs**
 - 500 ml pac: 70 pcs**
 Art no: 122166



OPEN FRONT PLEXI 1100
 W: 440 D: 440 H: 1320 mm**
 - 330 ml cans: 90 pcs**
 - 500 ml pac: 66 pcs**
 Art no: 121982



OPEN FRONT PLEXI 1350
 W: 440 D: 440 H: 1320 mm**
 - 330 ml cans: 90 pcs**
 - 500 ml pac: 66 pcs**
 Art no: 121984



OPEN FRONT PLEXI 1600
 W: 440 D: 440 H: 1620 mm**
 - 330 ml cans: 136 pcs**
 - 500 ml pac: 80 pcs**
 Art no: 121988



OPEN TOP CARDBOARD 40
 W: 440 D: 440 H: 960 mm**
 - 330 ml cans: 75 pcs**
 - 500 ml pac: 50 pcs**
 Art no: 121975



OPEN TOP PLEXI 40
 W: 440 D: 440 H: 1020 mm**
 - 330 ml cans: 75 pcs**
 - 500 ml pac: 50 pcs**
 Art no: 121971



OPEN FRONT CARDBOARD CABIN
 W: 440 D: 440 H: 1650 mm**
 - 330 ml cans: 133 pcs**
 - 500 ml pac: 96 pcs**
 Art no: 121989



Bild 6



Varu nummer	34310091E10000	Tariff kod	8418501990
EAN Kod	5704704015586	QTY i 40HQ	138

Mått och vikt	
Produkt dimension, HxBxD, mm	998 x 690 x 445
Paketmått HxBxD, mm	1120 x 740 x 490
Total paketvolym m ³	0,406
Bruttovolym, L	90
Nettovolym, L	60
Brutto- /nettovolym, L	90 / 60
Invändiga dimensioner HxBxD, mm	460 x 618 x 350
Brutto/nettovikt, kg	48 / 39

Kapacitet och förbrukning	
Energiklass	C
Daglig energi konsumtion, kWh/24	1,7
Årlig energiförbrukning kWh/a	620
Energi effektivitets index (EEI)	33,4
Luftburet ljud, dB(A)	57,3
Kyl och frysteknik	Ventilerad
Klimat klass	ST
Temperaturklass	H1
Kylvätska Typ / gaspåfyllning gr.	R290a / 60
Temperaturomfång °C	2 / 8

Installation och kraft	
Volt / hertz, V/hz	230 / 50
Peak power watt,W	199
Watt / Ampere, W/A	190 / 0,9
Längd på strömkabel, cm	250

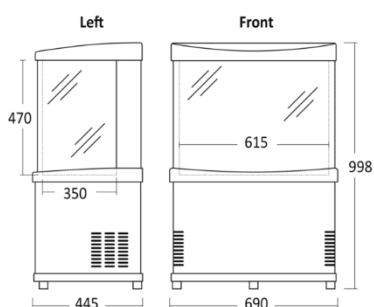

Impulskylarna presenterar produkterna väl och är i ögonhöjd, vilket fångar människors uppmärksamhet. VM 91 E rymmer 90 liter. Den böjda och genomskinliga fronten och den solida bakväggen gör den idealisk för placering mot en vägg. Den energisnåla LED-lampan ger ett bra ljus som representerar varorna extra bra i kylaren. Den ventilerade kylningen säkerställer en jämn fördelning av kylan i kylrummet och det genomskinliga locket behåller kylan. Elektronisk styrning och extern display gör det enkelt att se temperaturen. Justerbara ben så att den kan stå plant på alla ytor. VM 91 E lämpar sig utmärkt för branding och kan, om så önskas, dekoreras i din design för extra synlighet för varumärket.

BILD 7

Transparent sides for excellent product visibility | Four (4) vertical LEDs | Large an smooth surfaces for easy branding
Easy maintenance | Easy to move with high-quality and rotating wheels | Environment-friendly refrigerant R290



BILD 8



BILD 9



BILD 10



BILD 11



0,25L	280 pcs	0,33L	180 pcs	0,5L	90 pcs	0,6L	90 pcs
-------	---------	-------	---------	------	--------	------	--------

Print product info

Print User manual

TECHNICAL DETAILS

Net weight (kg)	80
Gross volume (l)	200
Net volume (l)	180
External dimensions W x D x H (mm)	650 x 450 x 1490
Internal dimensions W x D x H (mm)	380 x (260 x 2) x 885
Power input W (220-240V, 50Hz)	280
Defrosting	Automatic
Lighting	4 x vertical LED
Compressor	Danfoss
Refrigerant	R290
Evaporator type	Finned coil
Condenser type	Steel (maintenance free)
Temperature control	Electronical

TEMPERATURES

Temperature range	+1°C to +6°C
Operating conditions min - max	+10°C to +25°C/65%RH
Classification EN 23953	3H2

TRANSPORTATION

Gross weight (kg)	85
Package size W x D x H (mm)	600 x 800 x 1700
Quantity in 20ft container (pcs)	21
Quantity in 40ft container (pcs)	45
Quantity in 13,6m truck (pcs)	68

OPTIONS

Full branding	
Special color (RAL color system)	
Extra shelf / product dividers on shelves	

SUBSTER® SR 150

BILD 12



BILD 13



BILD 14





Bild 15

Transparent sides for excellent product visibility | LED lighting | Large and smooth surfaces for easy branding

Low energy consumption | Easy to maintain, both sides | Easy to move with high-quality rotating wheels

Environment-friendly refrigerant R600a

 Print product info

 Print User manual



0,20L	174 pcs	0,27L	160 pcs	0,33L	104 pcs	0,5L	100 pcs
-------	---------	-------	---------	-------	---------	------	---------

TECHNICAL DETAILS

Net weight (kg)	55
Gross volume (l)	100
Net volume (l)	95
External dimensions W x D x H (mm)	650 x 450 x 1010
Internal dimensions W x D x H (mm)	578 x (176 x 2) x 420
Power input W (220-240V, 50Hz)	170
Defrosting	Automatic
Lighting	2 x vertical LED
Compressor	Danfoss
Refrigerant	R600a
Evaporator type	Finned coil
Condenser type	Steel (maintenance free)
Temperature control	Electronical

TEMPERATURES

Temperature range	+1°C to +6°C
Operating conditions min - max	+10°C to +25°C/60%RH
Classification EN 23953	3M2

TRANSPORTATION

Gross weight (kg)	65
Package size W x D x H (mm)	800 x 600 x 1100
Quantity in 20ft container (pcs)	42
Quantity in 40ft container (pcs)	90
Quantity in 13,6m truck (pcs)	136

OPTIONS

Full branding	
Special color (RAL color system)	
Transparent cover	

SUBSTER® SR 100

Coreco Multideck

4 olika modeller

Rvc 1002 **2** dörrar kyl

Rvc 2003 **3** dörrar kyl

Cvc 1002 **2** dörrar frys

Cvc 2003 **3** dörrar frys

Automatisk avdunstning av avfrostningsvatten

Förångarfläkten stannar när dörren öppnas

Dubbelglasdörr + lysdioder

Kraftiga hyllor gjorda av belagd panel, höjjusterbar med stöd och etikethållare

mod.	rango range	largo length (mm)	alto height (mm)	fondo depth (mm)	potencia frig. frig. power (W)
RVC-1002	-2°C+8°C	1370	2040	810	845
CVC-1002	-25°C-18°C	1370	2040	810	907
RVC-2003	-2°C+8°C	2035	2040	810	2044
CVC-2003	-25°C-18°C	2035	2040	810	1814





XXL Premium

Fricon frysar SMR 2500 CLS VCC SVART
Fricon frysar SMR 2100 CLS VCC SVART
Fricon frysar SMR 2150 CLS VCC SVART (gavel)











TECHNICAL CARD SMR 25L CLS V1E2

Form.165.001

TECHNICAL SPECIFICATIONS					
EQUIPMENT TYPE	Conservator - Automatic Defrost - Variable Speed				
TEMPERATURE RANGE	<table border="1"> <tr> <td>AMBIENT</td> <td>16 61 / 30 86 °C / °F</td> </tr> <tr> <td>INNER*</td> <td>-24 °C / -16 °C -11,2 °F / 3,2 °F</td> </tr> </table>	AMBIENT	16 61 / 30 86 °C / °F	INNER*	-24 °C / -16 °C -11,2 °F / 3,2 °F
AMBIENT	16 61 / 30 86 °C / °F				
INNER*	-24 °C / -16 °C -11,2 °F / 3,2 °F				
VOLUME GROSS NET	1538L (54,3 ft ³) 878L (31 ft ³)				
EXTERNAL DIMENSIONS					
HEIGHT	990 mm				
DEPTH	1021 mm				
WIDTH	2508 mm				
INTERNAL DIMENSIONS					
HEIGHT	804 mm				
DEPTH	861 mm				
WIDTH	2360 mm				
INFO					
LID/DOOR TYPE	Lid - Glass				
TOTAL DISPLAY AREA	1,82 m ²				
INTERNAL COATING	Plastified Metal Sheet				
CLIMATE CLASS	3L1				
FREEZING CAPACITY	N.A.				

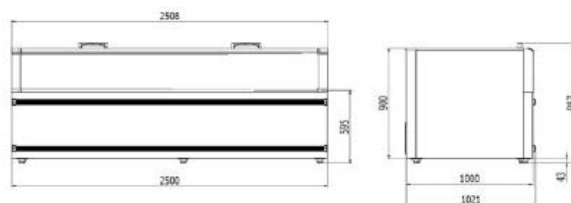

ENERGETIC FEATURES	
VOLTAGE/ FREQUENCY	220-240V / 50-60Hz
NOMINAL CURRENT	2,5 A
POWER	569 W
CONSUMPTION	6,44 kWh/24hr
ENERGY EFFICIENCY	C
NOISE LEVEL	<55 dB
ACCESSORIES	

COMPONENTS	
COMPRESSOR	Embraco
CONDENSER	Ventilated
THERMOSTAT	Carel - Digital
REFRIGERANT	R290
EVAPORATOR	Hidden
LIGHT	LED

Gavel 2142 x 1018 x 990



TECHNICAL CARD

Form.165.001

SMR 21T CLS V1E2

TECHNICAL SPECIFICATIONS					
EQUIPMENT TYPE	Conservator - Automatic Defrost - Variable Speed				
TEMPERATURE RANGE	<table border="1"> <tr> <td>AMBIENT</td> <td>16 61 / 30 86 °C / °F</td> </tr> <tr> <td>INNER*</td> <td>-24 °C / -16 °C -11,2 °F / 3,2 °F</td> </tr> </table>	AMBIENT	16 61 / 30 86 °C / °F	INNER*	-24 °C / -16 °C -11,2 °F / 3,2 °F
AMBIENT	16 61 / 30 86 °C / °F				
INNER*	-24 °C / -16 °C -11,2 °F / 3,2 °F				
VOLUME GROSS NET	1191L (42,1 ft ³) 672L (23,7 ft ³)				
EXTERNAL DIMENSIONS					
HEIGHT	990 mm				
DEPTH	1018 mm				
WIDTH	2142 mm				
INTERNAL DIMENSIONS					
HEIGHT	804 mm				
DEPTH	861 mm				
WIDTH	1960 mm				
INFO					
LID/DOOR TYPE	Lid - Glass				
TOTAL DISPLAY AREA	1,66 m ²				
INTERNAL COATING	Plastified Metal Sheet				
CLIMATE CLASS	3L1				
FREEZING CAPACITY	N.A.				

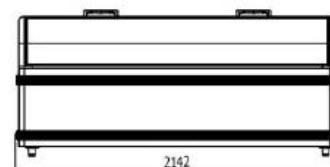
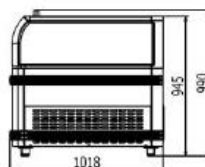

ENERGETIC FEATURES		COMPONENTS	
VOLTAGE/ FREQUENCY	220-240V / 50-60Hz	COMPRESSOR	Embraco
NOMINAL CURRENT	2,15 A	CONDENSER	Ventilated
POWER	433 W	THERMOSTAT	Carel - Digital
CONSUMPTION	6,59 kWh/24hr	REFRIGERANT	R290
ENERGY EFFICIENCY	C	EVAPORATOR	Hidden
NOISE LEVEL	<55 dB	LIGHT	LED
ACCESSORIES		PACKING LIST	
BASKETS	0		

Kylbänkar från 950-2450mm Med eller utan draglådor

TAVOLO
MID
DRIFTSTEMPERATUR
+ 2°C+ 8°C TN NORMAL TEMPERATUR

-18°C-22°C BT LÅG TEMPERATUR

ALLMÄNNA FUNKTIONER

In- och exteriör i rostfritt stål, förutom utvändig bas i galvaniserat stål
Rundade invändiga hörn
Flatbottnad monocoque-struktur, den kan placeras på en befintlig bas (vid borttagning av fötter)
Högtrycksinjicerad CFC-fri polyuretanisolering (densitet 40 kg / m³)
Isoleringstjocklek på TN-räknare (normaltemperatur): 50 mm
Isoleringstjocklek på BT-diskar (lågtemperatur): 50 mm
Självstängande dörrar med magnetisk packning
Elektronisk frontkontrollpanel med 1 NTC-sond för TN-räknare (normal temperatur), med 2 NTC-sonder för BT-räknare (låg temperatur)
Låsbart öppningsbart motorutrymme för enkel inspektion och rengöring av kondensorn
Standard extraherbar monoblock kylehet (rumstemperatur +30°C och relativ luftfuktighet 60%) enkel åtkomst för standardrengöring och underhåll
Räknare finns även i version för fjärrkondenseringsenhet
BT-räknare (lågtemperatur) är utrustade med förångarvärmare, avloppsvärmare, dörrkantvärmare och termostatventil;
Förångare med anti-korrosionskataforesbehandling
Helautomatisk avfrostning och kondensvattenavdunstning
Kit med nr. 4 justerbara fötter i rostfritt stål (höjd: 110/180 mm)
Enkel installation, redo att användas





Avo Harmony 135-87



Avo Harmony 140-60



Avo Harmony 170-54



Avo Harmony 170-87



MDC120 Pro G



Lumio 90



Luimo 145



Subster 100



Kristal italic 1400

- Temp. 1 - 5°C
- Gas, R290
- Går att få i bredd 1000, 1200 & 1400mm
- Höjd, 1404mm. Går att få i 1800mm



Kristal italic 1500

- Temp. 1 - 5°C
- Gas, R290
- Går att få i bredd 1000, 1200 & 1400mm
- Höjd, 1504mm. Går att få i 1800mm

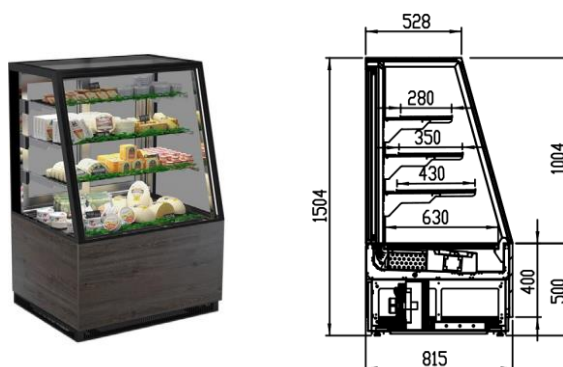

Kristal italic 1600

- Temp. 1 - 5°C
- Gas, R290
- Går att få i bredd 1000, 1200 & 1400mm
- Höjd, 1604mm. Går att få i 1800mm

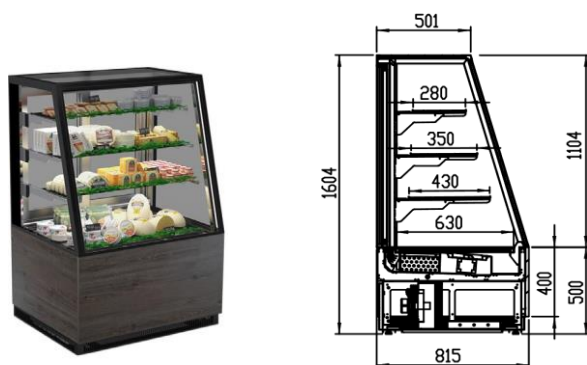

Kristal italic 1700

- Temp. 1 - 5°C
- Gas, R290
- Går att få i bredd 1000, 1200 & 1400mm
- Höjd, 1704mm. Går att få i 1800mm

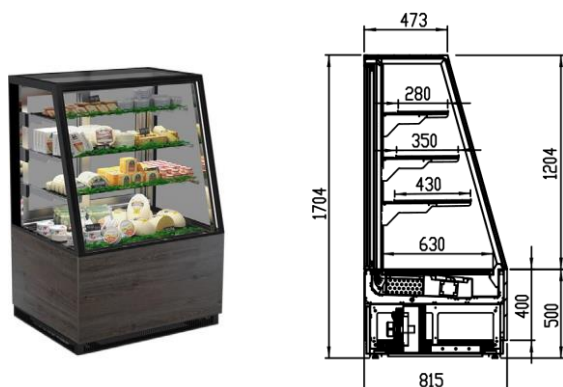

Kristal 1400

- Temp. 1 - 5°C
- Gas, R290
- Går att få i bredd 1000, 1200 & 1400mm
- Höjd, 1404mm. Går att få i 1800mm

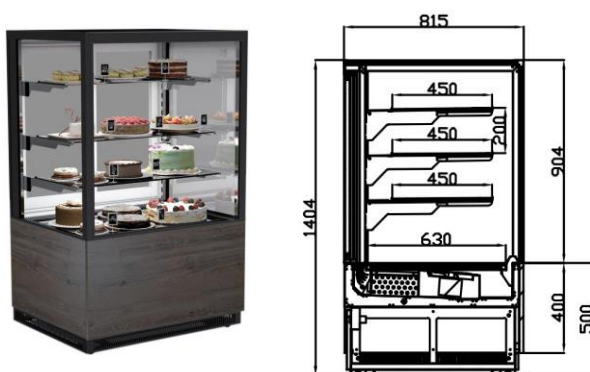

Kristal 1500

- Temp. 1 - 5°C
- Gas, R290
- Går att få i bredd 1000, 1200 & 1400mm
- Höjd, 1504mm. Går att få i 1800mm

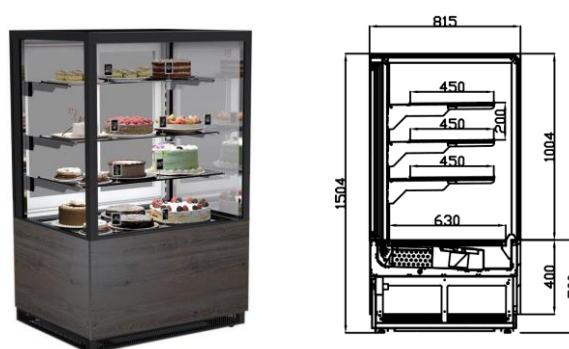

Kristal 1600

- Temp. 1 - 5°C
- Gas, R290
- Går att få i bredd 1000, 1200 & 1400mm
- Höjd, 1600mm. Går att få i 1800mm

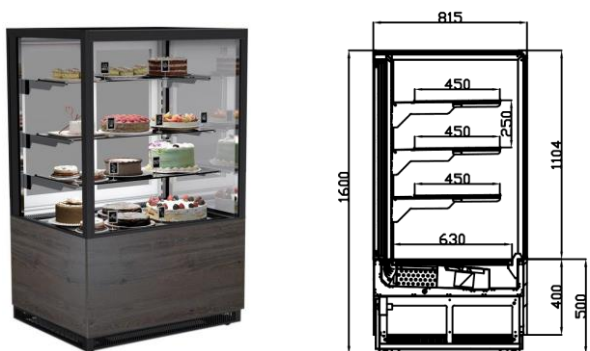

Kristal 1700

- Temp. 1 - 5°C
- Gas, R290
- Går att få i bredd 1000, 1200 & 1400mm
- Höjd, 1700mm. Går att få i 1800mm

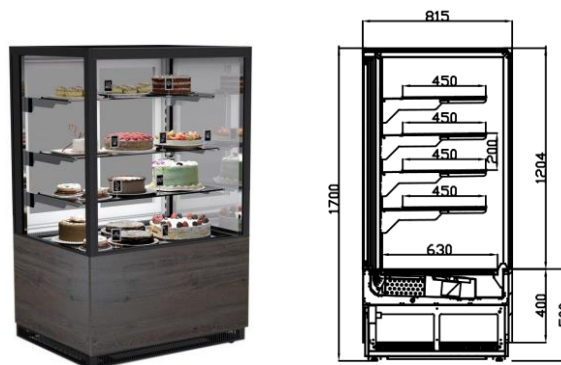

Mejeri/kylrum

- Tillverkas och anpassas efter era behov



Kaiser

- Temp. -1 - 5°C
- Gas, R290/R455A
- Går att få i bredd 937, 1250, 1875 & 2500mm
- Höjd, 1220mm
- Djup, 1060mm



Mini Bora Plug-In

- Temp. 2 - 8°C
- Gas, R290/R455A
- Bredd, 880mm
- Höjd, 1360mm
- Djup, 600mm



Bora Slim Multideck

- Temp. 2 - 8°C
- Gas, R290/R445A
- Går att få i bredd 937, 1120, 1250, 1500, 1874 & 2500mm
- Höjd, 2030mm
- Djup, 700mm



Oslo 700

- Temp. -1 - 5°C
- Gas, R290
- Med eller utan dörr (dubbel eller enkel glas)
- Går att få i bredd 973, 1250, 1875 & 2500mm
- Gavelkyl

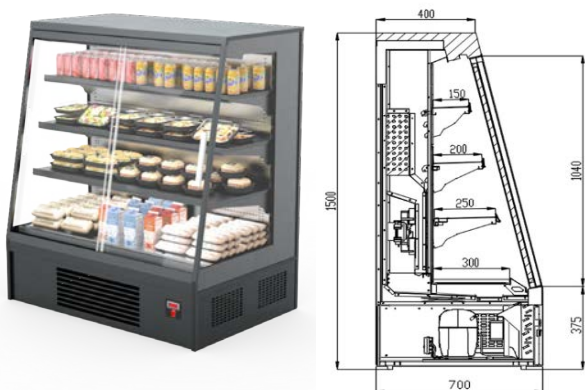

Oslo 900

- Temp. -1 - 5°C
- Gas, R290
- Med eller utan dörr (dubbel eller enkel glas)
- Går att få i bredd 973, 1250, 1875 & 2500mm
- Gavelkyl



Oslo Viking 700

- Temp. 1 - 5°C
- Gas, R290
- Med eller utan dörr (dubbel eller enkel glas)
- Går att få i bredd 973, 1250, 1875 & 2500mm

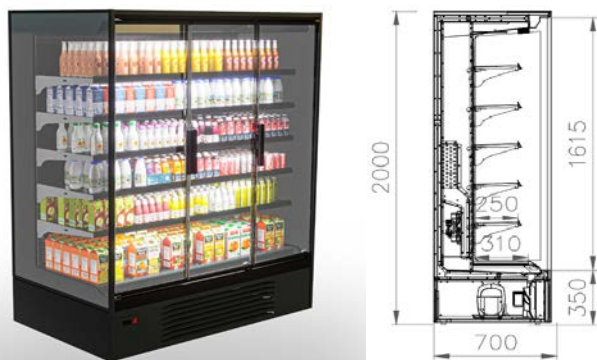

Oslo Viking 900

- Temp. 1 - 5°C
- Gas, R290
- Med eller utan dörr (dubbel eller enkel glas)
- Går att få i bredd 973, 1250, 1875 & 2500mm



Oslo VSV Semivertcal Multideck

2st 1350x870x1400 h

1st 1875x870x1400h

Temperatur -1°C till 5°C

Energieffektiv enhet Class B

3 hyllor plus botten LED under varje hylla

Öppen plus nattgardin

Innerfärg: Ral 9005

Utvändig färg: Ral 9005

Köldmedium R290A

LED ljus topp 6000K, 24V

Oslo VSV (Tårtbit)

1st 1800x870x1400 h

Full laminat 3 hyllor plus botten

NCS

RETAIL SOLUTIONS

°COOLFORS Cooling Systems

OFFERT



NCS RETAIL SOLUTIONS AB
Hantverkaregatan 16, SE-731 50 Köping, Sweden
Tel +46 (0)70-313 53 83, Fax +46 (0)221 237 50
info@go-ncs.se, www.go-ncs.se

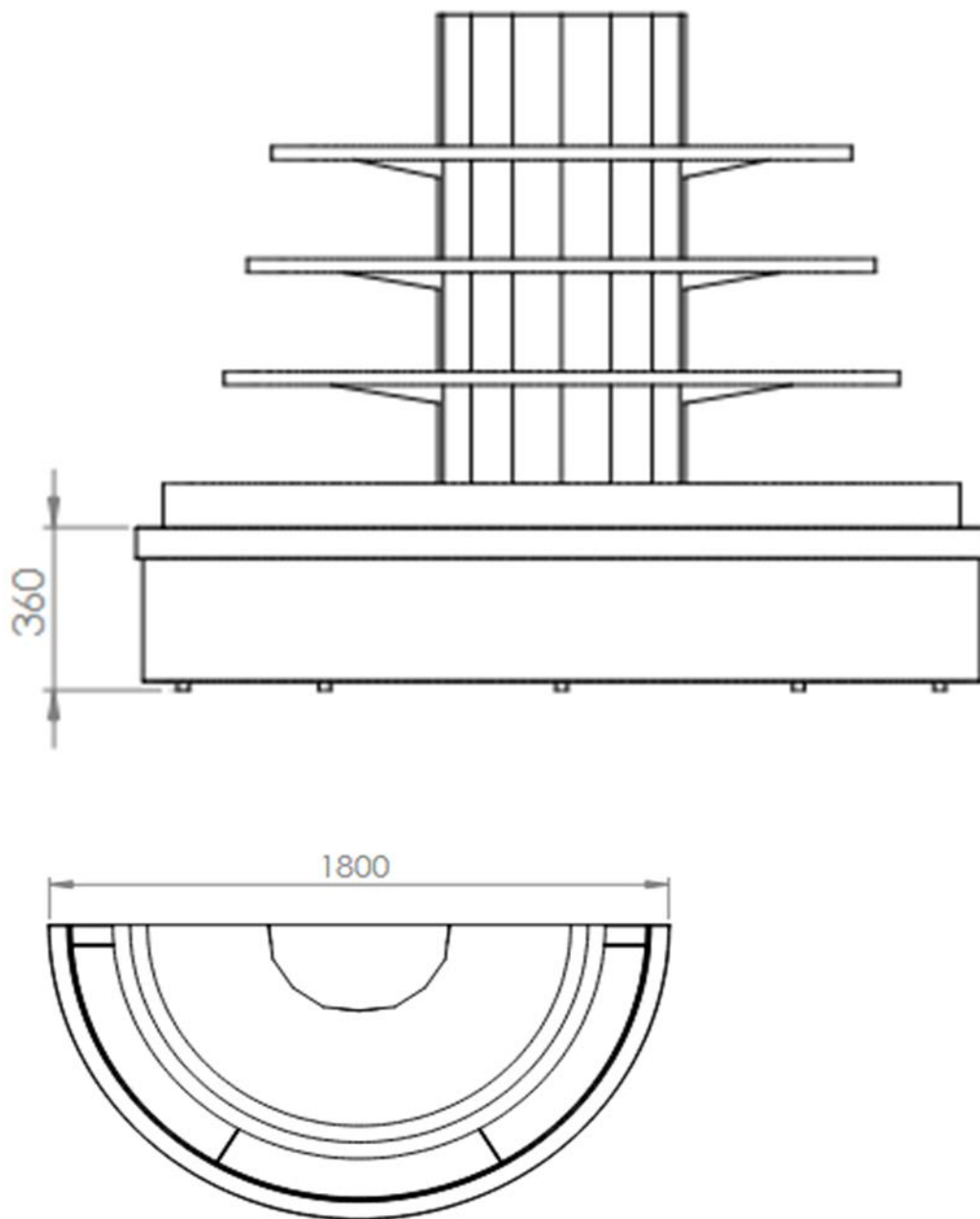

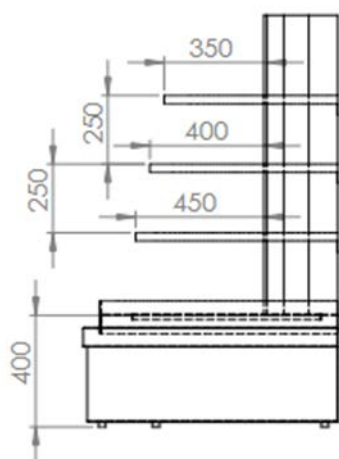
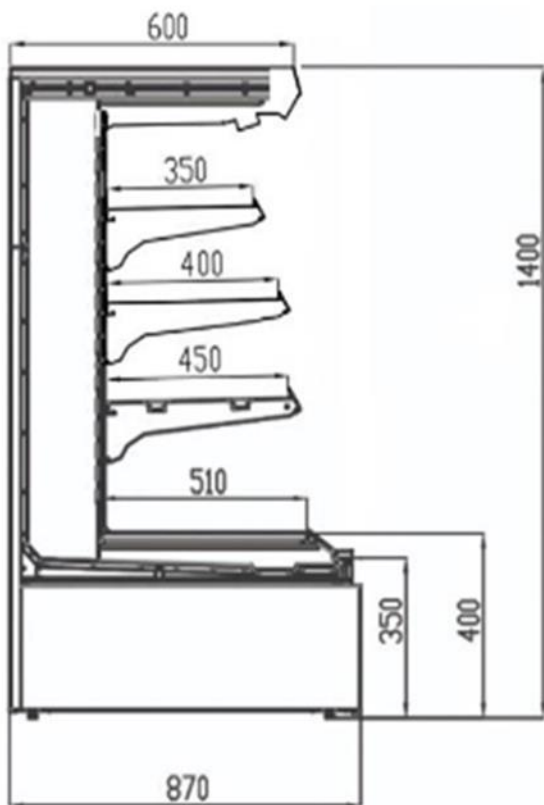



Oslo VSV Semivertcal Multideck Ö

2st 960x870x1400 h

Temperatur -1°C till 5°C

Energieffektiv enhet Class B

3 hyllor plus botten LED under varje hylla

Öppen plus nattgardin

Innerfärg: Ral 9005

Utvändig färg: Ral 9005

Köldmedium R290A

LED ljus topp 6000K, 24V

Oslo VSV (Tårtbit)

2st 1800x870x1400 h

Full laminat 3 hyllor plus botten

NCS

RETAIL SOLUTIONS

°COOLFORS Cooling Systems

OFFERT



NCS RETAIL SOLUTIONS AB
Hantverkaregatan 16, SE-731 50 Köping, Sweden
Tel +46 (0)70-313 53 83, Fax +46 (0)221 237 50
info@go-ncs.se, www.go-ncs.se

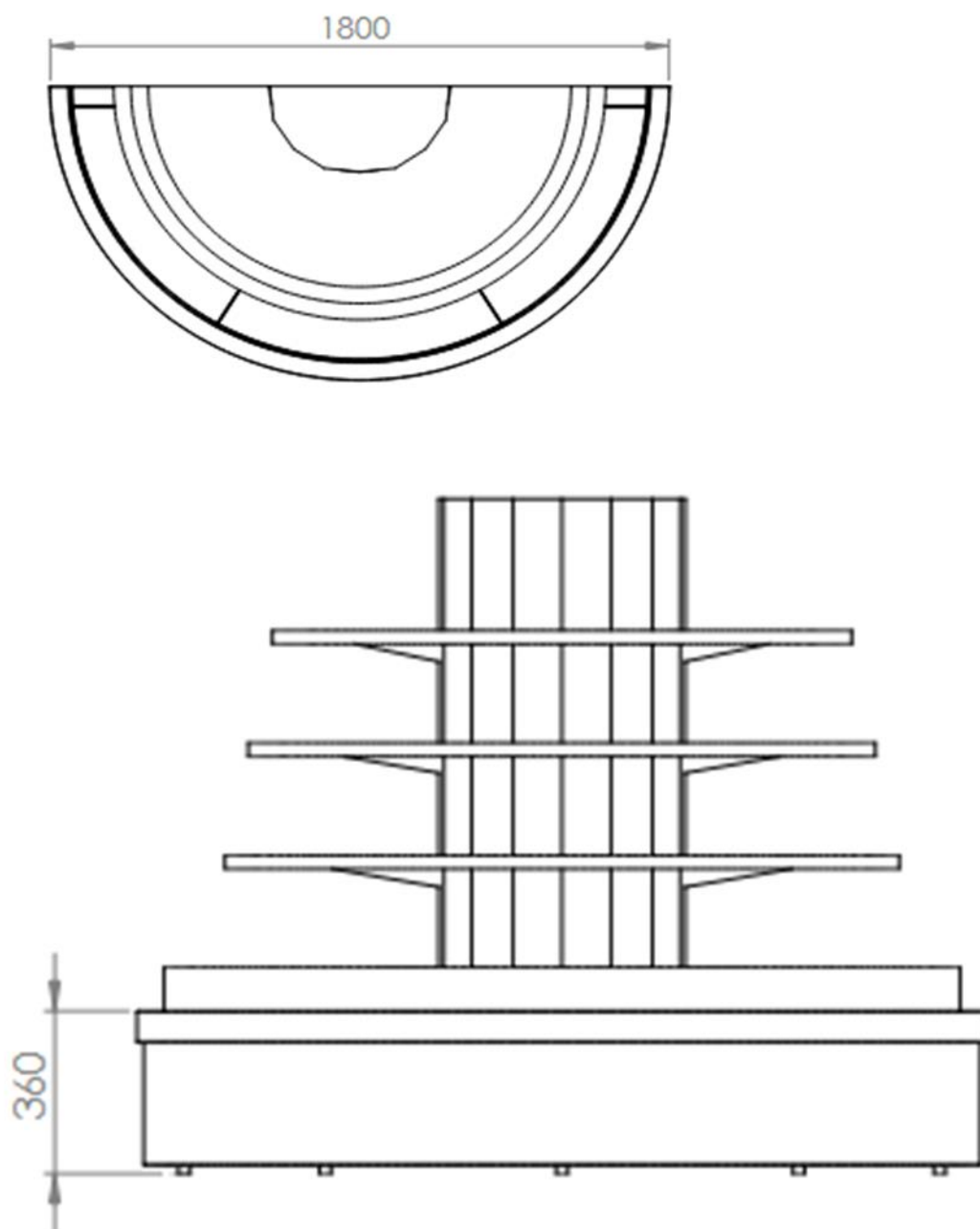

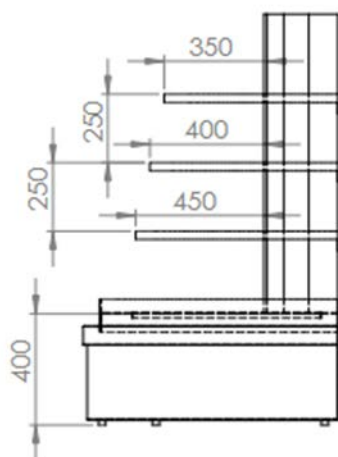
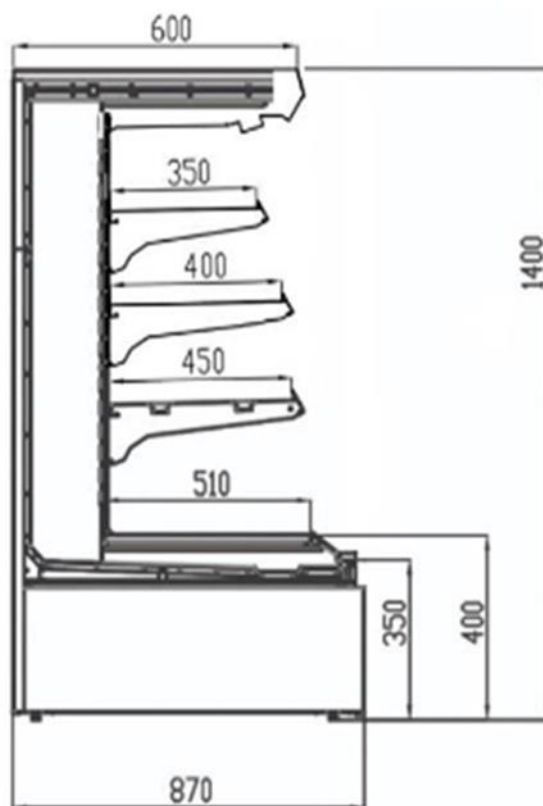



NCS

RETAIL SOLUTIONS

COOLFORS Cooling Systems

OFFERT



NCS RETAIL SOLUTIONS AB
Hantverkaregatan 16, SE-731 50 Köping, Sweden
Tel +46 (0)70-313 53 83, Fax +46 (0)221 237 50
info@go-ncs.se, www.go-ncs.se

PERFEKT PLUS 700TN (kyl)
PERFEKT NEGATIVE 700BN (frys)

R290

CLASSE B

Mått: 710x800x2030-2100mm

Beskrivning

Temperatur -2C till +10C (kyl)

Temperatur -16C till -22C (frys)

Italiensk 700L rostfritt skåp

Passar till 2/1 GN kantiner och här får du verkligen kvalité för pengarna.

60 mm isolering

650 W max (Frys)

385 W max (Kyl)

Justerbara fötter

Magnetisk dörrkarm

Höger eller vänsterhängd

Automatisk avfrostning

3x 2/1 GN trådhyllor

Hyll plan inkl. 2 konsoler

Invändig belysning

Lås med nyckel

4 hjul



